

## NPN-Silizium-Fototransistor Silicon NPN Phototransistor

BPY 62

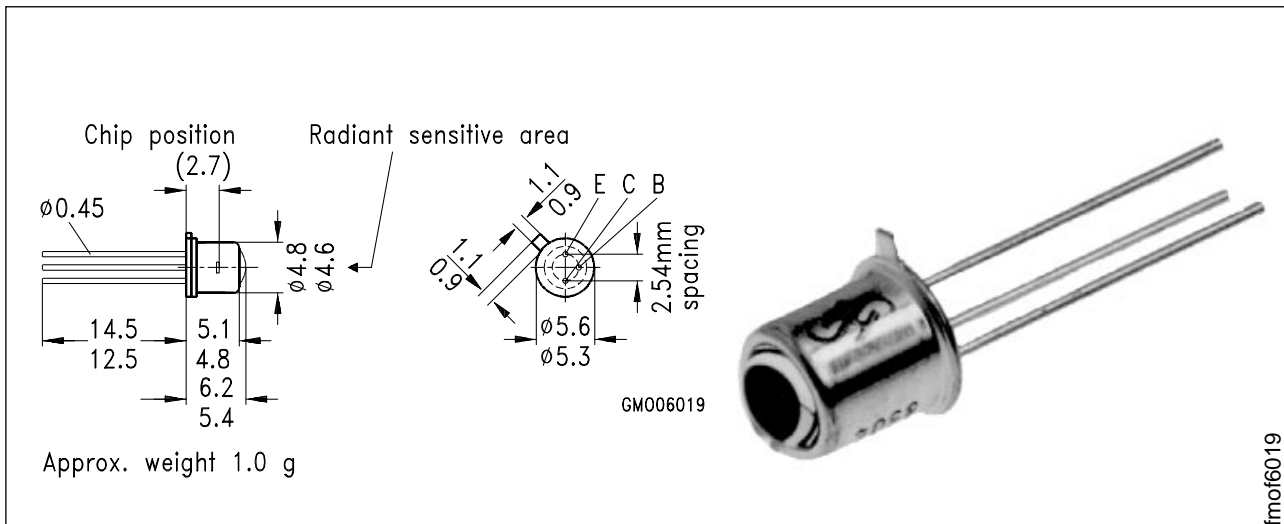

Maße in mm, wenn nicht anders angegeben/Dimensions in mm, unless otherwise specified

### Wesentliche Merkmale

- Speziell geeignet für Anwendungen im Bereich von 420 nm bis 1130 nm
- Hohe Linearität
- Hermetisch dichte Metallbauform (TO-18) mit Basisanschluß, geeignet bis 125 °C
- Gruppiert lieferbar

### Anwendungen

- Lichtschranken für Gleich- und Wechsellichtbetrieb
- Industrieelektronik
- "Messen/Steuern/Regeln"

### Features

- Especially suitable for applications from 420 nm to 1130 nm
- High linearity
- Hermetically sealed metal package (TO-18) with base connection suitable up to 125 °C
- Available in groups

### Applications

- Photointerrupters
- Industrial electronics
- For control and drive circuits

Typ Type	Bestellnummer Ordering Code
BPY 62	Q60215-Y62
BPY 62-2	Q60215-Y1111
BPY 62-3	Q60215-Y1112
BPY 62-4	Q60215-Y1113
BPY 62-5 <sup>1)</sup>	Q62702-P1113

1) Eine Lieferung in dieser Gruppe kann wegen Ausbeuteschwankungen nicht immer sichergestellt werden. Wir behalten uns in diesem Fall die Lieferung einer Ersatzgruppe vor.

1) Supplies out of this group cannot always be guaranteed due to unforeseeable spread of yield. In this case we will reserve us the right of delivering a substitute group.

## Grenzwerte Maximum Ratings

Bezeichnung Description	Symbol Symbol	Wert Value	Einheit Unit
Betriebs- und Lagertemperatur Operating and storage temperature range	$T_{op}; T_{stg}$	- 55 ... + 125	°C
Löttemperatur bei Tauchlötung Lötstelle $\geq 2$ mm vom Gehäuse, Lötzeit $t \leq 5$ s Dip soldering temperature $\geq 2$ mm distance from case bottom, soldering time $t \leq 5$ s	$T_S$	260	°C
Löttemperatur bei Kolbenlötung Lötstelle $\geq 2$ mm vom Gehäuse, Lötzeit $t \leq 3$ s Iron soldering temperature $\geq 2$ mm distance from case bottom, soldering time $t \leq 3$ s	$T_S$	300	°C
Kollektor-Emitterspannung Collector-emitter voltage	$V_{CE}$	50	V
Kollektorstrom Collector current	$I_C$	100	mA
Kollektorspitzenstrom, $\tau < 10 \mu s$ Collector surge current	$I_{CS}$	200	mA
Emitter-Basisspannung Emitter-base voltage	$V_{EB}$	7	V
Verlustleistung, $T_A = 25 \text{ }^\circ\text{C}$ Total power dissipation	$P_{tot}$	200	mW
Wärmewiderstand Thermal resistance	$R_{thJA}$	500	K/W

**Kennwerte** ( $T_A = 25\text{ °C}$ ,  $\lambda = 950\text{ nm}$ )

### Characteristics

Bezeichnung Description	Symbol Symbol	Wert Value	Einheit Unit
Wellenlänge der max. Fotoempfindlichkeit Wavelength of max. sensitivity	$\lambda_{S\max}$	850	nm
Spektraler Bereich der Fotoempfindlichkeit $S = 10\%$ von $S_{\max}$ Spectral range of sensitivity $S = 10\%$ of $S_{\max}$	$\lambda$	420 ... 1130	nm
Bestrahlungsempfindliche Fläche Radiant sensitive area	$A$	0.12	mm <sup>2</sup>
Abmessung der Chipfläche Dimensions of chip area	$L \times B$ $L \times W$	0.5 × 0.5	mm × mm
Abstand Chipoberfläche zu Gehäuseoberfläche Distance chip front to case surface	$H$	2.4 ... 3.0	mm
Halbwinkel Half angle	$\varphi$	± 8	Grad deg.
Fotostrom der Kollektor-Basis-Fotodiode Photocurrent of collector-base photodiode $E_e = 0.5\text{ mW/cm}^2$ , $V_{CB} = 5\text{ V}$ $E_v = 1000\text{ lx}$ , Normlicht/standard light A, $V_{CB} = 5\text{ V}$	$I_{PCB}$ $I_{PCB}$	4.5 17	μA μA
Kapazität Capacitance $V_{CE} = 0\text{ V}$ , $f = 1\text{ MHz}$ , $E = 0$ $V_{CB} = 0\text{ V}$ , $f = 1\text{ MHz}$ , $E = 0$ $V_{EB} = 0\text{ V}$ , $f = 1\text{ MHz}$ , $E = 0$	$C_{CE}$ $C_{CB}$ $C_{EB}$	8 11 19	pF pF pF
Dunkelstrom Dark current $V_{CE} = 35\text{ V}$ , $E = 0$	$I_{CEO}$	5 (≤ 100)	nA

Die Fototransistoren werden nach ihrer Fotoempfindlichkeit gruppiert und mit arabischen Ziffern gekennzeichnet.

The phototransistors are grouped according to their spectral sensitivity and distinguished by arabian figures.

Bezeichnung Description	Symbol Symbol	Wert Value				Einheit Unit
		-2	-3	-4	-5	
Fotostrom, $\lambda = 950 \text{ nm}$ Photocurrent $E_e = 0.5 \text{ mW/cm}^2$ , $V_{CE} = 5 \text{ V}$ $E_v = 1000 \text{ lx}$ , Normlicht/standard light A, $V_{CE} = 5 \text{ V}$	$I_{PCE}$ $I_{PCE}$	0.5 ... 1.0 3.0	0.8 ... 1.6 4.6	1.25 ... 2.5 7.2	$\geq 2.0$ 11.4	mA mA
Anstiegszeit/Abfallzeit Rise and fall time $I_C = 1 \text{ mA}$ , $V_{CC} = 5 \text{ V}$ , $R_L = 1 \text{ k}\Omega$	$t_r$ , $t_f$	5	7	9	12	$\mu\text{s}$
Kollektor-Emitter-Sättigungsspannung Collector-emitter saturation voltage $I_C = I_{PCEmin}^{1)} \times 0.3$ , $E_e = 0.5 \text{ mW/cm}^2$	$V_{CEsat}$	150	150	160	180	mV
Stromverstärkung Current gain $E_e = 0.5 \text{ mW/cm}^2$ , $V_{CE} = 5 \text{ V}$	$\frac{I_{PCE}}{I_{PCB}}$	170	270	420	670	

1)  $I_{PCEmin}$  ist der minimale Fotostrom der jeweiligen Gruppe

1)  $I_{PCEmin}$  is the min. photocurrent of the specified group

### Relative spectral sensitivity

$$S_{rel} = f(\lambda)$$

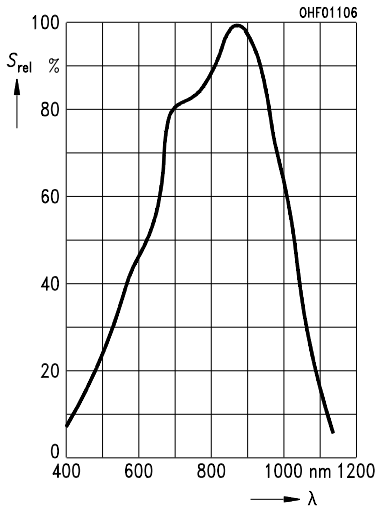

### Photocurrent

$$I_{PCE} = f(E_e), V_{CE} = 5 \text{ V}$$

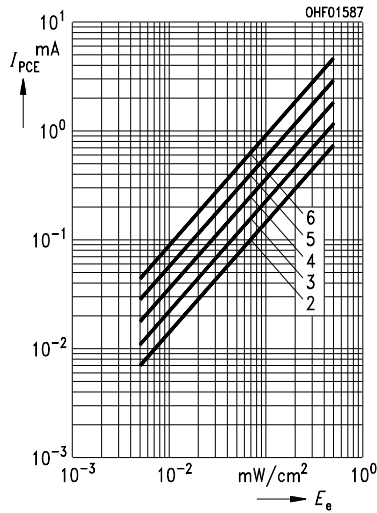

### Total power dissipation

$$P_{tot} = f(T_A)$$

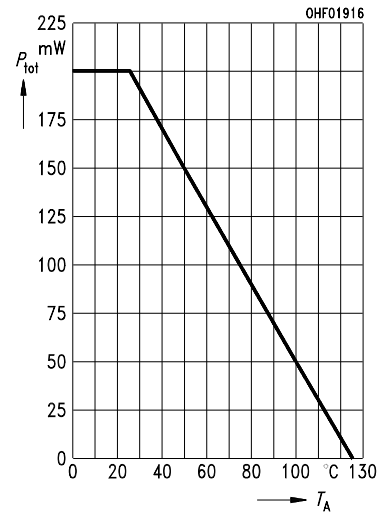

### Output characteristics

$$I_C = f(V_{CE}), I_B = \text{Parameter}$$

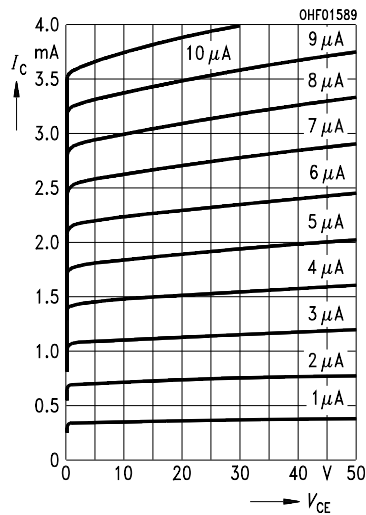

### Output characteristics

$$I_C = f(V_{CE}), I_B = \text{Parameter}$$

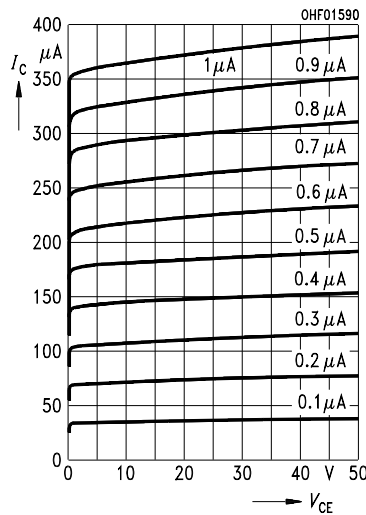

### Dark current

$$I_{CEO} = f(V_{CE}), E = 0$$

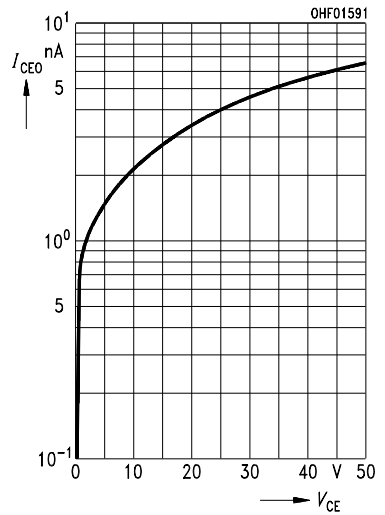

### Photocurrent

$$I_{PCE}/I_{PCE25^\circ} = f(T_A), V_{CE} = 5 \text{ V}$$

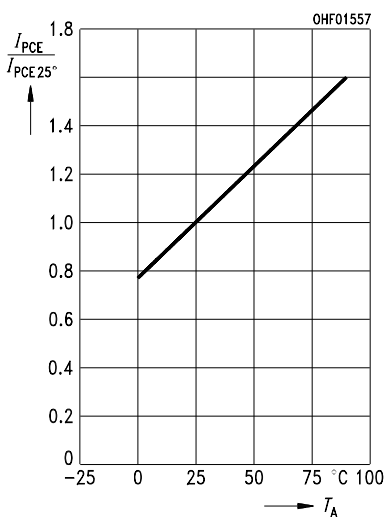

### Dark current

$$I_{CEO}/I_{CEO25^\circ} = f(T_A), V_{CE} = 25 \text{ V}, E = 0$$

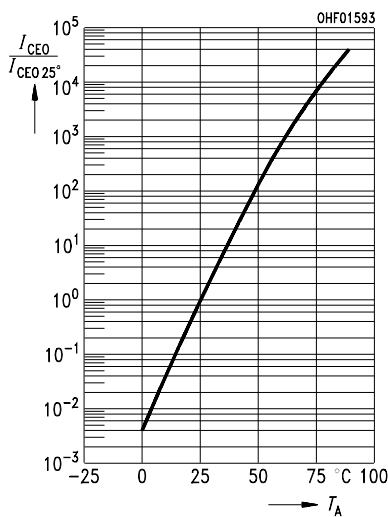

### Collector-emitter capacitance

$$C_{CE} = f(V_{CE}), f = 1 \text{ MHz}, E = 0$$

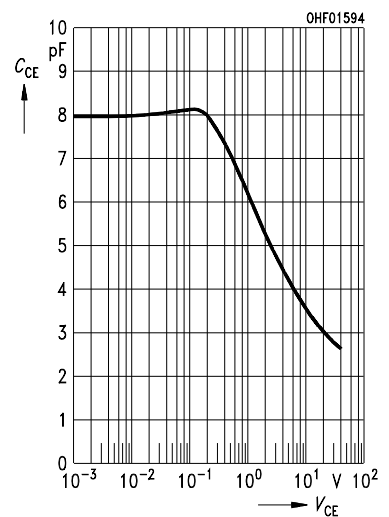

### Collector-base capacitance

$$C_{CB} = f(V_{CB}), f = 1 \text{ MHz}, E = 0$$

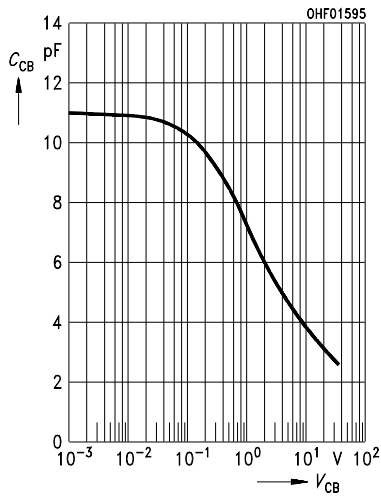

### Emitter-base capacitance

$$C_{EB} = f(V_{EB}), f = 1 \text{ MHz}, E = 0$$

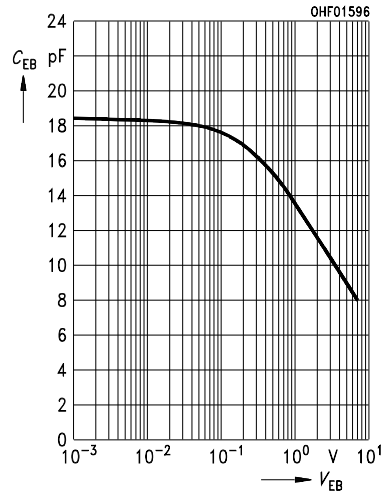

### Directional characteristics $S_{rel} = f(\varphi)$

